

Coupled Field-Circuit Problem: A Generalized Signal Flow Graph Description of the Circuit Equations

H. De Gersem, R. Mertens, U. Pahner, K. Hameyer and R. Belmans
Katholieke Universiteit Leuven
Dep. E.E./ESAT - Div. ELEN
Kardinaal Mercierlaan 94
B-3001 Leuven (Heverlee), Belgium

Résumé - On présente une théorie d'arbre généralisée en vue de traiter tous les types de connexions possibles entre des conducteurs pleins et bobinés dans un circuit électrique couplé avec une model éléments finis magnétique. Un Signal Flow Graph généralisé est utilisé pour déterminer les inconnues courants et tensions utilisé dans une description symétrique des équations de circuits. La méthode évoquée est appliquée à un exemple.

Abstract - A generalized tree theory is presented in order to deal with all possible connections of solid and stranded conductors in an electric circuit coupled with a magnetic Finite Element model. A generalized Signal Flow Graph is used to determine the unknown currents and voltages necessary to describe the circuit behaviour in a symmetric way. The method is applied to an example. The aim of this paper is to state a general network theory able to deal with all possible connections of voltage and current sources, impedances, solid and stranded conductors leading to a symmetric and compact coupling matrix without zero diagonals.

1. INTRODUCTION

External circuit connections were first considered in 1976 [1]. A lot of formulations are made in the 1980's [2]. During the past decade [2,3,4,5] the coupling of field and circuit equations has become well-known and generally applied. However, some implementations deal with only one conductor type, solid or stranded respectively, [5,6,7] or do not allow connected graphs containing both types [4]. Here, a new generalized formulation is systematically derived to consider both, stranded and solid conductors simultaneously. For various reasons some reported approaches do not symmetrize the matrix [8]. On the other hand, if symmetrized, it is done on the matrix level only [9]. The aim of this paper is to state a general network theory, able to deal with all possible connections of voltage and current sources, impedances, solid and stranded conductors leading to a symmetric and compact coupling matrix without zero diagonals. It is shown that the graph theory offers a general way of describing the field-circuit coupling problem. Contracting the graph leads to a reduced and symmetric system in a natural way. The advantage of a symmetric matrix is a reduced computation time.

2. FORMULATION

The magnetic induction \mathbf{B} and the electric field \mathbf{E} are modelled in terms of the magnetic vector potential \mathbf{A} and the electric scalar potential V [10]. In stranded conductors no skin effect is involved. Consequently the current density \mathbf{J} is assumed to be constant. In the case of a 2D time-harmonic problem, the formulations and their associated discrete forms

are in non-conducting regions (1), stranded conductor regions (2) and solid conductor regions (3) respectively

$$\nabla \times \nu \nabla \times \mathbf{A} = 0$$

$$\text{and } \sum_j K_{ij} \cdot A_j = 0 \quad (1)$$

$$\nabla \times \nu \nabla \times \mathbf{A} = \mathbf{J}$$

$$\text{and } \sum_j K_{ij} \cdot A_j = -T_i \cdot \frac{N_t}{\Delta_{\text{str}}} \cdot I_{\text{str}} = -P_i \cdot I_{\text{str}} \quad (2)$$

$$\nabla \times \nu \nabla \times \mathbf{A} + \sigma \frac{\partial \mathbf{A}}{\partial t} = \sigma \nabla V$$

$$\text{and } \sum_j (K_{ij} + L_{ij}) \cdot A_j = -T_i \cdot \frac{\sigma}{\ell} \cdot V_{\text{sol}} = -Q_i \cdot V_{\text{sol}} \quad (3)$$

where the elements are determined by

$$K_{ij} = \int_{\Omega} \nu \nabla N_i \cdot \nabla N_j \, d\Omega; L_{ij} = \int_{\Omega} j\omega\sigma N_i N_j \, d\Omega; T_i = \int_{\Omega} N_i \, d\Omega \quad (4)$$

ν is the magnetic reluctivity and ℓ is the length of the conductors in the FE model. N_t is the number of strands, Δ_{str} is the total area of strands in the FE model and I_{str} is the current per strand. σ is the conductivity of the solid conductor material, ∇V is the gradient of the voltage and V_{sol} is the voltage drop in the solid conductor. N_i is the form function associated with node i .

3. CIRCUIT CONDITIONS

If an external circuit is modelled, I_{str} and V_{sol} are not longer known. The righthandsides of (2) and (3) go to the lefthandsides. Extra equations are added to the system. It is obvious that the best way to couple a magnetic field based on a magnetic vector potential formulation with an external circuit, is to define an unknown voltage V_{sol} for each solid conductor, respectively an unknown current I_{str} for each stranded conductor [8]. The voltage drop of a series connection of N_t strands is given by

$$V_{\text{str}} = \frac{N_t^2 \cdot \ell}{\sigma \cdot f \cdot \Delta_{\text{str}}} \cdot I_{\text{str}} + \sum_i \frac{j\omega N_t \cdot \ell}{\Delta_{\text{str}}} \cdot T_i \cdot A_i = R_{\text{str}} \cdot I_{\text{str}} + V_{\text{ind}} \quad (5)$$

where f is the fill factor of the stranded conductor. The voltage drop of the stranded conductor is splitted up in a resistive part $R_{\text{str}} I_{\text{str}}$ and an inductive part V_{ind} . In the electric network topology a stranded conductor can consequently be replaced by a series connection of an impedance branch and a controlled voltage source.

The total current through a solid bar is given by

$$I_{\text{sol}} = \frac{\sigma \cdot \Delta_{\text{sol}}}{\ell} \cdot V_{\text{sol}} - \sum_i j\omega\sigma \cdot T_i \cdot A_i = G_{\text{sol}} \cdot V_{\text{sol}} + I_{\text{ind}} \quad (6)$$

where Δ_{sol} is the area of the solid conductor in the FE region. The total current through the solid conductor is distinguished in a resistive part $G_{\text{sol}}V_{\text{sol}}$ and an inductive part I_{ind} . A solid conductor can be seen as a parallel connection of an admittance branch and a controlled current source.

In a time-harmonic 2D formulation, multiplying (5) and (6) with the symmetrizing factor $\chi = \frac{j}{\omega\ell}$ yields in the circuit conditions

$$\sum_i P_i \cdot A_i + \chi \cdot V_{\text{str}} - \chi \cdot R_{\text{str}} \cdot I_{\text{str}} = 0 \quad (7)$$

$$\sum_i Q_i \cdot A_i + \chi \cdot G_{\text{sol}} \cdot V_{\text{sol}} - \chi \cdot I_{\text{sol}} = 0 \quad (8)$$

This important multiplication causes the desired symmetry of the coefficients P_i of the unknown A_i in (7) with the same coefficients of the unknown I_{str} in (2) and the coefficients Q_i of the unknown A_i in (8) with the same coefficients of the unknown V_{sol} in (3).

4. EXTERNAL CIRCUITS

An external circuit is taken into account by defining extra circuit unknowns and circuit equations. Dependent on the method, unknown currents or voltages are chosen. The tableau analysis considers all possible equations. A Modified Nodal Analysis (MNA) produces a smaller set of equations in terms of nodal voltages. Stranded conductors and voltage sources results in extra unknown currents and their corresponding equations. A symmetric system is obtained by eliminating those currents (Compact Modified Nodal Analysis). However, the sparsity of the FEM-equations for the stranded conductor areas decreases [2].

A *loop* is a circuit path that has the same begin and end node. A *cutset* is a set of branches which removal splits the circuit in two parts. A *tree* is a set of branches that connects all nodes and has no loops. The set of the remaining branches is the *cotree*. A member of the cotree is a *link*. A *fundamental loop* is a loop formed by one link and a set of tree branches. A *fundamental cutset* is a cutset formed by one tree branch and a set of links [11].

Mixed stranded and solid conductors in a network cause problems to describe the circuit. Matrices obtained by a separate analysis of stranded and solid conductors can not be arranged. Here the circuit theory indicates a problem. In Fig. 1a solid conductors form a loop. In Fig. 1b stranded conductors form a cutset. Replacing the magnetic branches, as indicated in (5) and (6), fails. In this case cutsets containing a stranded conductor branch include solid conductor branches. Loops holding a solid conductor branch include stranded conductor branches.

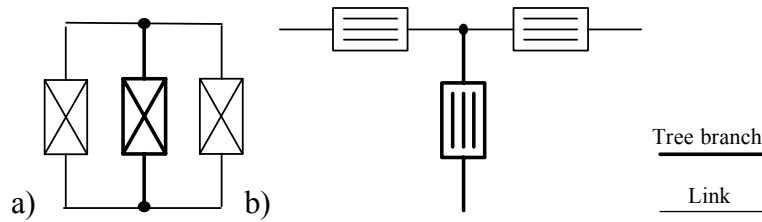

Fig. 1. a) Star-connected stranded conductors and b) solid conductors connected in parallel.

5. SIGNAL FLOW GRAPH

A topological method for circuit analysis is a technique which derives parameters describing the circuit behaviour from the structure of a graph, associated with the network. Some topological methods are the Signal Flow Graph method and the tree-enumeration method. In this paper, a description based on the Signal Flow Graph of the electrical circuit will lead to a coupled matrix system of magnetic FE and circuit equations. A Signal Flow Graph (SFG) is a weighted directed graph representing a system of linear equations. The SFGs of the coupling equations (5) and (6) are seen in Fig. 2.

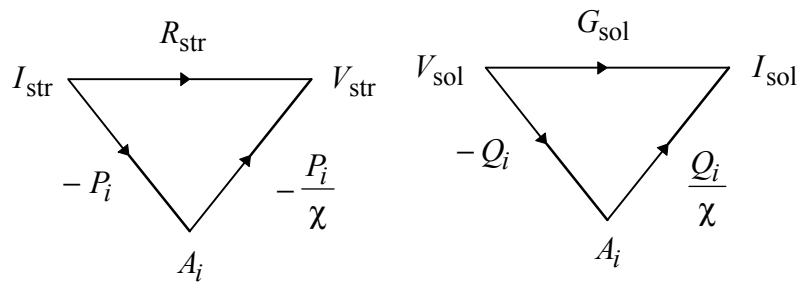

Fig. 2. SFG of the electric-magnetic coupling terms.

The network consists of independent voltage sources, solid conductors, immittance (impedance or admittance) elements, stranded conductors and independent current sources. It is assumed that the voltage sources do not contain loops and the current sources do not include cutsets.

A tree is built following a privileged order: independent voltage sources, solid conductors, admittances and stranded conductors. The order of preference of cotree elements is: independent current sources, stranded conductors, impedances and solid conductors. Some stranded conductors may be tree branches. Some solid conductors may be links. As a benchmark model consider a single phase induction motor. Two stranded conductors are connected in series and fed by a voltage source, two solid rotor bars are short-circuited (Fig. 3). The bold lines indicate tree branches whereas normal lines are representing links.

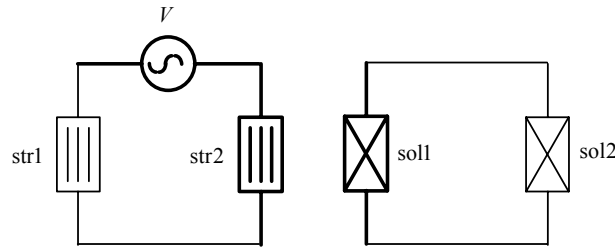

Fig. 3. Enumerated circuit of a single phase induction motor.

The SFG is built by putting a node for each tree branch voltage and link current. Extra nodes are added for unknown currents of stranded conductors that are part of the tree and solid conductors that are part of the cotree. The Kirchoff Current Law (KCL) and the Kirchoff Voltage Law (KVL) are indicated by arrows between the nodes. A *independent node* is a node with only outwards oriented arrows. A *dependent node* is a node with at least one inwards oriented arrow. A *sink node* is a dependent node with only inwards oriented branches [12]. Fig. 4 shows the not-connected primitive SFG of the benchmark model.

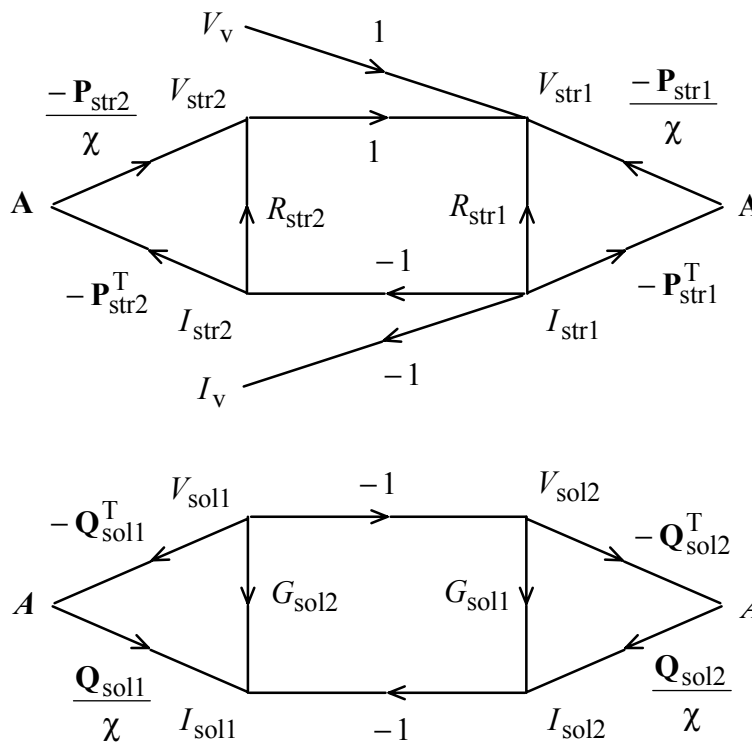

Fig. 4. Primitive Signal Flow Graph of the single phase induction motor.

The SFG represents a non-symmetric coupled system. Table I shows the equivalences between the SFG and matrix calculus. The *fundamental cutset matrix* \mathbf{D} represents the incidences of the circuit branches to the fundamental cutsets. The *fundamental loop matrix* \mathbf{B} represents the incidences of the circuit branches to the fundamental loops [13]. Each of

the matrices is partitioned in parts associated with the stranded conductors that are links ("str"), those that are tree branches ("str*"), the solid conductors that are tree branches ("sol"), those that are links ("sol*"), the independent sources ("i" and "v") and the immittance tree branches ("T") and links ("L").

Table I. Equivalence between circuit theory, Signal Flow Graph and matrix calculus.

Circuit Analysis	Signal Flow Graph	Matrix notation
Kirchhoff Current Law	current nodes	$\mathbf{D} \cdot \mathbf{I} = 0$
Kirchhoff Voltage Law	voltage nodes	$\mathbf{B} \cdot \mathbf{V} = 0$
Branch Relations	vertical connections	$\mathbf{V} = \mathbf{R} \cdot \mathbf{I}; \mathbf{I} = \mathbf{G} \cdot \mathbf{V}$
cutset transformation	eliminate $\mathbf{V}_{str*}, \mathbf{I}_{str*}$	$\mathbf{I}_{str*} = -\mathbf{D}_{str*,i} \cdot \mathbf{I}_i - \mathbf{D}_{str*,str} \cdot \mathbf{I}_{str}$
loop transformation	eliminate $\mathbf{V}_{sol*}, \mathbf{I}_{sol*}$	$\mathbf{V}_{sol*} = -\mathbf{B}_{sol*,v} \cdot \mathbf{V}_v - \mathbf{B}_{sol*,sol} \cdot \mathbf{V}_{sol}$
compacting	eliminate $\mathbf{V}_{str}, \mathbf{V}_L, \mathbf{I}_{sol}, \mathbf{I}_T$	$\mathbf{V}_L = \mathbf{Z}_L \cdot \mathbf{I}_L; \mathbf{I}_T = \mathbf{Y}_T \cdot \mathbf{V}_T$

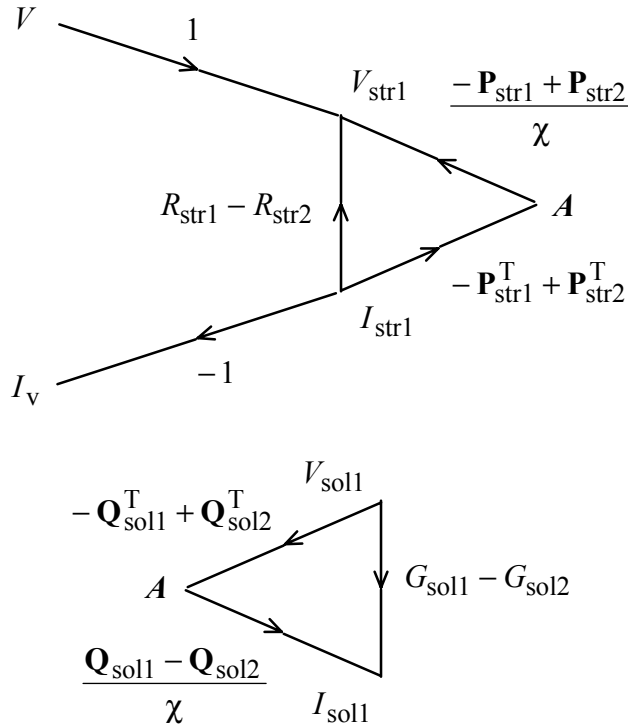

Fig. 5. Compact Signal Flow Graph of the single phase induction motor.

The system is contracted and symmetrized in three steps.

1. The currents of the stranded conductor tree branches are eliminated by a *partial cutset transformation* (Table I).
2. The voltages of the solid conductor links are eliminated by a *partial loop transformation* (Table I).
3. Finally, eliminating the tree branch currents and the link voltages (Table I) leads to a *Compact Signal Flow Graph* (CSFG) (Fig. 5) representing a symmetric coupled field-circuit matrix.

$$\begin{bmatrix} \mathbf{K} & \mathbf{M}^T \\ \mathbf{M} & \chi \cdot \mathbf{S} \end{bmatrix} \cdot \begin{bmatrix} \mathbf{A} \\ \mathbf{C} \end{bmatrix} = \begin{bmatrix} \mathbf{H} \\ \chi \cdot \mathbf{N} \end{bmatrix} \quad (9)$$

where \mathbf{K} is the FE matrix constructed as in (1), (2) and (3), \mathbf{A} is the column of the unknown magnetic vector potentials,

$$\mathbf{H} = \mathbf{P}_{\text{str}^*}^T \cdot \mathbf{D}_{\text{str}^*,i} \cdot \mathbf{I}_i + \mathbf{Q}_{\text{sol}^*}^T \cdot \mathbf{B}_{\text{sol}^*,v} \cdot \mathbf{V}_v \quad (9a)$$

$$\mathbf{M} = \begin{bmatrix} \mathbf{P}_{\text{str}} - \mathbf{B}_{\text{str},\text{str}^*} \cdot \mathbf{P}_{\text{str}^*} & \mathbf{0} & -\mathbf{Q}_{\text{sol}} + \mathbf{D}_{\text{sol},\text{sol}^*} \cdot \mathbf{Q}_{\text{sol}^*} & \mathbf{0} \end{bmatrix} \quad (9b)$$

$$\mathbf{S} = \begin{bmatrix} \mathbf{R}_{\text{str}}^* & \mathbf{0} & -\mathbf{B}_{\text{str},\text{sol}} & -\mathbf{B}_{\text{str},\text{T}} \\ \mathbf{0} & \mathbf{Z}_L & -\mathbf{B}_{L,\text{sol}} & -\mathbf{B}_{L,\text{T}} \\ \mathbf{D}_{\text{sol},\text{str}} & \mathbf{D}_{\text{sol},L} & -\mathbf{G}_{\text{sol}}^* & \mathbf{0} \\ \mathbf{D}_{\text{T},\text{str}} & \mathbf{D}_{\text{T},L} & \mathbf{0} & -\mathbf{Y}_T \end{bmatrix} \quad (9c)$$

with

$$\mathbf{R}_{\text{str}}^* = \mathbf{R}_{\text{str}} - \mathbf{B}_{\text{str},\text{str}^*} \cdot \mathbf{R}_{\text{str}^*} \cdot \mathbf{D}_{\text{str}^*,\text{str}} \quad (9d)$$

$$\mathbf{G}_{\text{sol}}^* = \mathbf{G}_{\text{sol}} - \mathbf{D}_{\text{sol},\text{sol}^*} \cdot \mathbf{G}_{\text{sol}^*} \cdot \mathbf{B}_{\text{sol}^*,\text{sol}} \quad (9e)$$

$$\mathbf{C} = \begin{bmatrix} \mathbf{I}_{\text{str}} & \mathbf{I}_L & -\mathbf{V}_{\text{sol}} & -\mathbf{V}_T \end{bmatrix}^T \quad (9f)$$

and

$$\mathbf{N} = \begin{bmatrix} \mathbf{B}_{\text{str},v} \cdot \mathbf{V}_v - \mathbf{B}_{\text{str},\text{str}^*} \cdot \mathbf{Z}_{\text{str}^*} \cdot \mathbf{D}_{\text{str}^*,i} \cdot \mathbf{I}_i \\ \mathbf{B}_{z,v} \cdot \mathbf{V}_v \\ \mathbf{D}_{\text{sol},i} \cdot \mathbf{I}_i - \mathbf{D}_{\text{sol},\text{sol}^*} \cdot \mathbf{Y}_{\text{sol}^*} \cdot \mathbf{B}_{\text{sol}^*,v} \cdot \mathbf{V}_v \\ \mathbf{D}_{y,i} \cdot \mathbf{I}_i \end{bmatrix} \quad (9g)$$

\mathbf{K} is symmetric [10]. \mathbf{S} is symmetric because of the property $\mathbf{B}_{x,y} = -\mathbf{D}_{y,x}^T$ [11] and due to the fact that \mathbf{R}_{str} , $\mathbf{R}_{\text{str}^*}$, \mathbf{G}_{sol} , $\mathbf{G}_{\text{sol}^*}$, \mathbf{Z}_L and \mathbf{Y}_T are diagonals.

6. SOLVING THE SYSTEM OF LINEAR EQUATIONS

The matrix obtained for a 2D time-harmonic solution coupled with an electric circuit described with the proposed method is complex, symmetric, has no zero diagonal elements but is not-Hermitian. However, the FEM block is positive definite and the circuit coupling block is negative definite [2]. Therefore, the Conjugate Gradient (CG) method can not be used. Other suggestions are the BiConjugate Gradient (BiCG) method, the Conjugate Gradient method on the Normal Equations (CGN), other orthogonalizing Krylov-subspace methods and Block Elimination Schemes (BES) [9]. In the example, it is shown that the CGN method is faster when compared to the BiCG method.

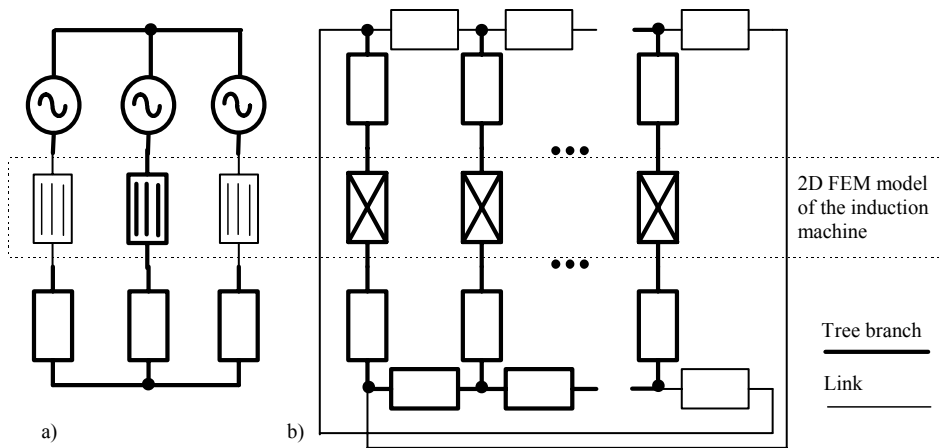

Fig. 6. Electric circuit of a) the stator and b) of the rotor of an induction motor.

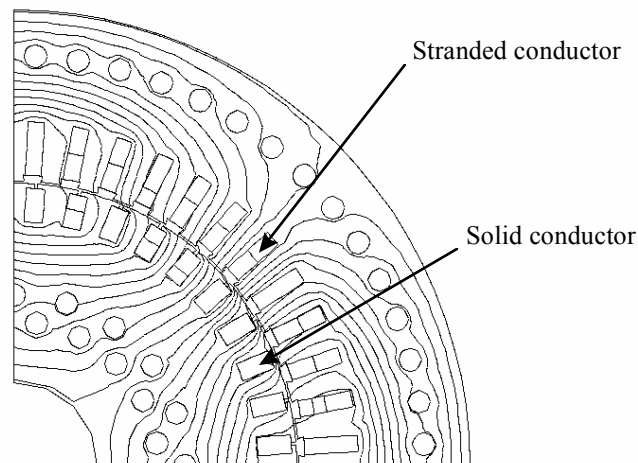

Fig. 7. Flux line plot of the time-harmonic 50 Hz solution of a loaded induction motor.

7. EXAMPLE

The circuit in Fig. 6 describes a voltage excitation of the stator winding and the connection of ten rotor bars with end-rings including end-effects of a four pole induction motor. Both stranded and solid conductors are present. A flux line plot of the time-harmonic solution is shown in Fig. 7. The numbers of circuit equations for several topological methods are presented in Table II. The new approach results in a smaller and symmetric system of equations. This allows the use of simple and well-known iterative solvers.

Table II. Number of circuit equations.

Circuit Analysis	Tableau	MNA	CMNA	SFG
Number of circuit equations	166	46	43	31
Appropriate solvers	GMRES	GMRES	CGN, BiCG	CGN, BiCG

8. CONCLUSIONS

A new and generalized approach for field-circuit coupling is presented considering both types of conductors simultaneously, stranded and solid respectively. The dependences of field unknowns and circuit unknowns are represented by a Signal Flow Graph. Difficulties due to strange circuit connections are overcome by appropriate transformations of the graph. Matrix operations equivalent to the graph transformations are reducing and symmetrizing the coupled system. The method is successfully applied to a time-harmonic 2D calculation of a loaded induction machine.

ACKNOWLEDGEMENT

The authors are grateful to the Belgian Fonds voor Wetenschappelijk Onderzoek - Vlaanderen for its financial support of this work and the Belgian Ministry of Scientific Research for granting the IUAP No. P4/20 on Coupled Problems in Electromagnetic Systems.

REFERENCES

- [1] Hannalla A.Y. and Macdonald D.C., Proc. IEE, **123**(9) (1976) 893-898.
- [2] Tsukerman I.A., Konrad A., Meunier G. and Sabonnadière J.C., IEEE Trans. Magn. **29** (1993) 1701-1704.
- [3] Tsukerman I.A., Konrad A., Bedrosian G. and Chari M.V.K., IEEE Trans. Magn. **29** (1993) 1711-1716.
- [4] Lombard P. and Meunier G., IEEE Trans. Magn. **29** (1993) 1737-1740.
- [5] Dreher Th. and Meunier G., IEEE Trans. Magn. **29** (1993) 1341-1344.
- [6] Tsukerman I.A., IEEE Trans. Magn. **31** (1993) 1857-1860.
- [7] Tsukerman I.A., Konrad A. and Lavers J.D. , IEEE Trans. Magn. **28**(2) (1992) 1299-1302.
- [8] Bedrosian G., IEEE Trans. Magn. **29** (1993) 1664-1668.
- [9] Gyselinck J. and Melkebeek J., "Numerical methods for time stepping coupled field-circuit systems", ELECTRIMACS' 96 Saint-Nazaire 1996, pp. 227-232.
- [10] Silvester P.P. and Ferrari R.L., Finite elements for electrical engineers (Cambridge University Press, Cambridge, 1996) pp. 344-359.
- [11] Chua L.O. and Lin P.M., Computer Aided Analysis of Electronic Circuits - Algorithms and Computational Techniques (Prentice-Hall, New Jersey, 1975) pp. 131-165.
- [12] Lin P.M., Symbolic Network Analysis (Elsevier, Amsterdam, 1991).
- [13] Chua L.O. and Lin P.M., Computer Aided Analysis of Electronic Circuits - Algorithms and Computational Techniques (Prentice-Hall, New Jersey, 1975) pp. 539-578.